

Varenummer: 202724B3040SW

Beskrivelse: E+G Sensor holder - GN 272.4-B30-40-SW

Mål

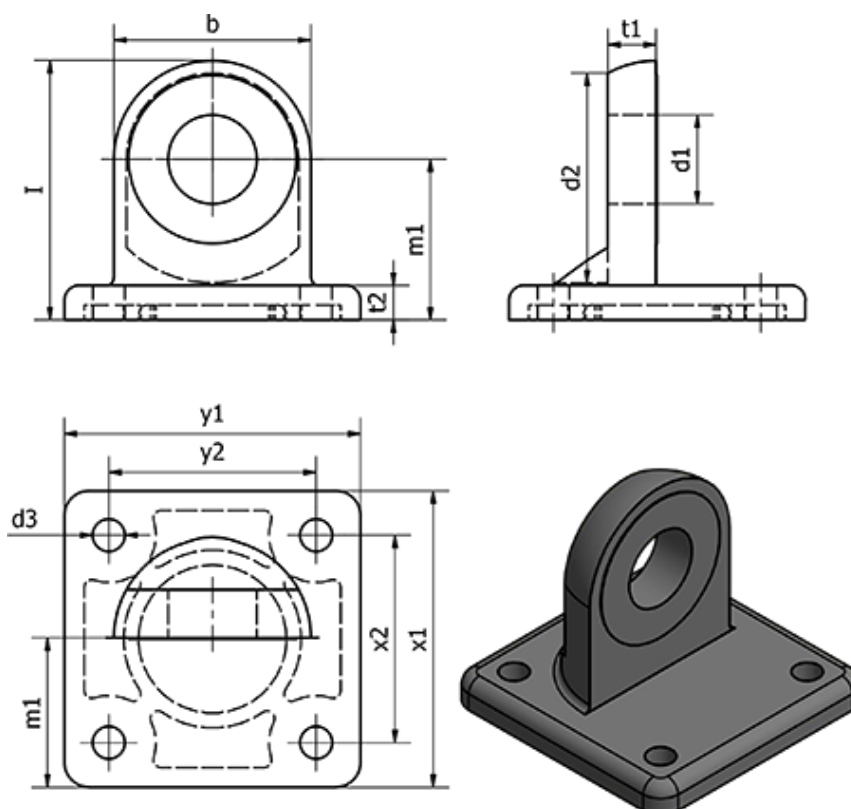

b	= 40	t2	= 7
d1	= B 30	Vægt (g)	= 100
d2	= 50	x1	= 60
d3	= 6.5	x2	= 42
l	= 52.5	y1	= 60
m1	= 32.5	y2	=
m2	= 30		
t1 -0,5	= 10		